

# Hydraulic Hose and Fittings

**DTC**

**Global Crimp Fittings - High Pressure**

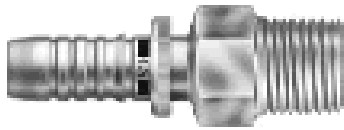

**GS-MP**

G20100 Series - Male NPT	
G20100-0606	6GS-6MP
G20100-0808	8GS-8MP
G20100-1212	12GS-12MP
G20100-1216	12GS-16MP
G20100-1616	16GS-16MP
G20100-2020	20GS-20MP
81410	24PCS-24MP
81411	32PCS-32MP

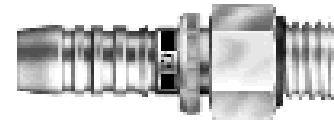

**GS-MB**

G20120 Series - Male O-Ring Boss	
G20120-0606	6GS-6MB
G20120-0808	8GS-8MB
G20120-0810	8GS-10MB
G20120-1010	10GS-10MB
G20120-1012	10GS-12MB
G20120-1212	12GS-12MB
G20120-1216	12GS-16MB
G20120-1612	16GS-12MB
G20120-1616	16GS-16MB
G20120-2020	20GS-20MB

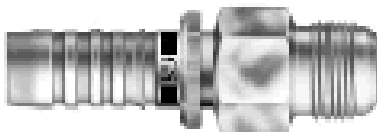

**GS-MJ**

G20165 Series - Male JIC	
G20165-0606	6GS-6MJ
G20165-0808	8GS-8MJ
G20165-0810	8GS-10MJ
G20165-1010	10GS-10MJ
G20165-1012	10GS-12MJ
G20165-1212	12GS-12MJ
G20165-1216	12GS-16MJ
G20165-1616	16GS-16MJ
G20165-2020	20GS-20MJ
81409	24PCS-24MJ
81437	32PCS-32MJ

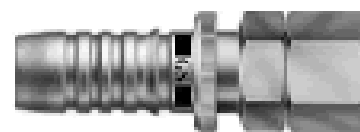

**GS-FJX**

G20170 Series - Female JIC Swivel	
G20170-0606	6GS-6FJX
G20170-0608	6GS-8FJX
G20170-0808	8GS-8FJX
G20170-0810	8GS-10FJX
G20170-0812	8GS-12FJX
G20170-1010	10GS-10FJX
G20170-1012	10GS-12FJX
G20170-1210	12GS-10FJX
G20170-1212	12GS-12FJX
G20170-1214	12GS-14FJX
G20170-1216	12GS-16FJX
G20170-1612	16GS-12FJX
G20170-1616	16GS-16FJX
G20170-1620	16GS-20FJX
G20170-2020	20GS-20FJX
G20170-2024	20GS-24FJX
81440	24PCS-24FJX
83328	24PCM-24FJX
81439	24PCS-32FJX
81442	32PCS-32FJX

**E35**

# Hydraulic Hose and Fittings

**DTC**

**Global Crimp Fittings - High Pressure**



GS-FJX45S  
GS-FJX45M  
GS-FJX45L

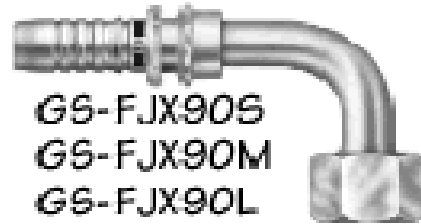

GS-FJX90S  
GS-FJX90M  
GS-FJX90L  
GS-FJX90XL

## G20174 Series - Female JIC Swivel 45 Degree

G20174-0606	6GS-6FJX45S
G20174-0608	6GS-8FJX45S
G20174-0808	8GS-8FJX45S
G20174-0810	8GS-10FJX45S
G20174-1010	10GS-10FJX45S
G20174-1012	10GS-12FJX45S
G20174-1212	12GS-12FJX45S
G20174-1216	12GS-16FJX45S
G20174-1616	16GS-16FJX45S
G20174-1620	16GS-20FJX45S
G20174-2020	20GS-20FJX45S
81307	24PCS-24FJX45M

## G20179 Series - Female JIC Swivel Short Drop

G20179-0606	6GS-6FJX90S
G20179-0608	6GS-8FJX90S
G20179-0808	8GS-8FJX90S
G20179-0810	8GS-10FJX90S
G20179-0812	8GS-12FJX90S
G20179-1010	10GS-10FJX90S
G20179-1212	12GS-12FJX90S
G20179-1216	12GS-16FJX90S
G20179-1616	16GS-16FJX90S
G20179-2020	20GS-20FJX90S
81257	24PCS-24FJX90



GS-FJX90S  
GS-FJX90M  
GS-FJX90L  
GS-FJX90XL



GS-FJX90S  
GS-FJX90M  
GS-FJX90L  
GS-FJX90XL

## G20180 Series - Female JIC Swivel Medium Drop

G20180-0608	6GS-8FJX90M
G20180-0808	8GS-8FJX90M
G20180-0810	8GS-10FJX90M
G20180-1012	10GS-12FJX90M
G20180-1212	12GS-12FJX90M
G20180-1216	12GS-16FJX90M
G20180-1616	16GS-16FJX90M
G20180-2020	20GS-20FJX90M
7343-0321	24PCM-24FJX90M

## G20181 Series - Female JIC Swivel Long Drop

G20181-0606	6GS-6FJX90L
G20181-0808	8GS-8FJX90L
G20181-0810	8GS-10FJX90L
G20181-1212	12GS-12FJX90L
G20181-1616	16GS-16FJX90L
G20181-1620	16GS-20FJX90L
G20181-2020	20GS-20FJX90L

E36

# Hydraulic Hose and Fittings

**DTC**

**Global Crimp Fittings - High Pressure**

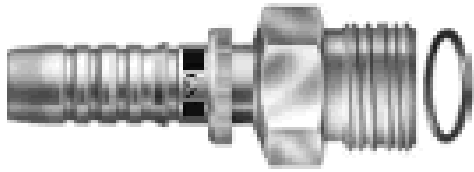

**GS-MFFOR**

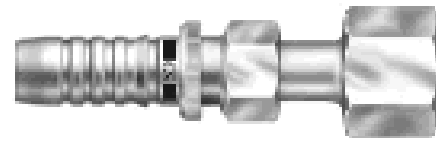

**GS-FFORX**

## G20225 Series - Male Flat Face O-Ring

G20225-0606	6GS-6MFFOR
G20225-0808	8GS-8MFFOR
G20225-1010	10GS-10MFFOR
G20225-1212	12GS-12MFFOR
G20225-1216	12GS-16MFFOR
G20225-1616	16GS-16MFFOR
G20225-2020	20GS-20MFFOR

## G20230 Series - Female Flat Face O-Ring Swivel

G20230-0606	6GS-6FFORX
G20230-0608	6GS-8FFORX
G20230-0808	8GS-8FFORX
G20230-0810	8GS-10FFORX
G20230-0812	8GS-12FFORX
G20230-1010	10GS-10FFORX
G20230-1012	10GS-12FFORX0
G20230-1210	12GS-10FFORX
G20230-1212	12GS-12FFORX
G20230-1216	12GS-16FFORX
G20230-1616	16GS-16FFORX
G20230-1620	16GS-20FFORX
G20230-2020	20GS-20FFORX
81034	24PCS-24FFORX



**GS-FFORX45S**



**GS-FFORX90S**  
**GS-FFORX90M**  
**GS-FFORX90L**

## G20234 Series - Female Flat Face O-Ring Swivel 45 Degree

G20234-0606	6GS-6FFORX45S
G20234-0608	6GS-8FFORX45S
G20234-0808	8GS-8FFORX45S
G20234-0810	8GS-10FFORX45S
G20234-1010	10GS-10FFORX45S
G20234-1212	12GS-12FFORX45S
G20234-1616	16GS-16FFORX45S
G20234-1620	16GS-20FFORX45S
G20234-2020	20GS-20FFORX45-032
81056	24PCS-24FFORX45

## G20239 Series - Female Flat Face O-Ring Swivel 90 Degree Short Drop

G20239-0606	6GS-6FFORX90S
G20239-0808	8GS-8FFORX90S
G20239-1010	10GS-10FFORX90S
G20239-1212	12GS-12FFORX90S
G20239-1216	12GS-16FFORX90S
G20239-1616	16GS-16FFORX90S
G20239-1620	16GS-20FFORX90S
G20239-2020	20GS-20FFORX90S
81066	24PCS-24FFORX90S

**E37**

# Hydraulic Hose and Fittings

**DTC**

**Global Crimp Fittings - High Pressure**



GS-FFORX90S  
GS-FFORX90M  
GS-FFORX90L



GS-FFORX90S  
GS-FFORX90M  
GS-FFORX90L

## G20240 Series - Female Flat Face O-Ring Swivel 90 Degree Medium Drop

G20240-0608	6GS-8FFORX90M
G20240-0808	8GS-8FFORX90M
G20240-0810	8GS-10FFORX90M
G20240-1010	10GS-10FFORX90M
G20240-1212	12GS-12FFORX90M
G20240-1616	16GS-16FFORX90M
G20240-2020	20GS-20FFORX90M
81074	24PCS-24FFORX90M
83052	24PCM-24FFORX90M

## G20241 Series - Female Flat Face O-Ring Swivel 90 Degree Long Drop

G20241-0606	6GS-6FFORX90L
G20241-0808	8GS-8FFORX90L
G20241-1010	10GS-10FFORX90L
G20241-1212	12GS-12FFORX90L
G20241-1616	16GS-16FFORX90L
G20241-2020	20GS-20FFORX90L
81084	24PCS-24FFORX90L

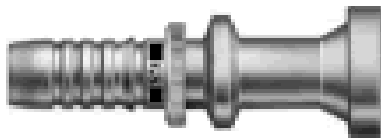

GS-FL



GS-FL22M

## G20300 Series - Code 61 Flange

G20300-0808	8GS-8FL
G20300-0810	8GS-10FLK
G20300-0812	8GS-12FL
G20300-1212	12GS-12FL
G20300-1216	12GS-16FL
G20300-1616	16GS-16FL
G20300-1620	16GS-20FL
G20300-2016	20GS-16FL
G20300-2020	20GS-20FL
G20300-2024	20GS-24FL
81463	24PCS-24FL
81464	24PCS-32FL
81466	32PCS-24FL
81465	32PCS-32FL
83338	24PCM-24FL
83339	32PCM-32FL

## G20302 Series - Code 61 Flange 22 Degree

G20302-1212	12GS-12FL22M
G20302-1616	16GS-16FL22M
G20302-1620	16GS-20FL22M
G20302-2020	20GS-20FL22M
G20302-2024	20GS-24FL22M
81476	24PCS-20FL22
81474	24PCS-24FL22
81317	24PCS-32FL22
81477	32PCS-24FL22
81475	32PCS-32FL22

E38

# Hydraulic Hose and Fittings

**DTC**

**Global Crimp Fittings - High Pressure**



## G20304 Series - Code 61 Flange 30 Degree

G20304-1212	12GS-12FL30M
G20304-1216	12GS-16FL30M
G20304-1616	16GS-16FL30M
G20304-1620	16GS-20FL30M
G20304-2020	20GS-20FL30M
G20304-2024	20GS-24FL30M
81484	24PCS-24FL30
81318	24PCS-32FL30

## G20307 Series - Code 61 Flange 45 Degree

G20307-0808	8GS-8FL45M
G20307-1012	10GS-12FL45M
G20307-1212	12GS-12FL45M
G20307-1616	16GS-16FL45M
G20307-1620	16GS-20FL45M
81498	24PCS-20FL45
81495	24PCS-24FL45
81496	24PCS-32FL45
81499	32PCS-24FL45
81497	32PCS-32FL45

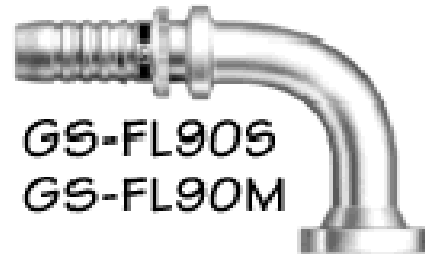

## G20309 Series - Code 61 Flange 60 Degree

G20309-1212	12GS-12FL60M
G20309-1216	12GS-16FL60M
G20309-1616	16GS-16FL60M
G20309-2020	20GS-20FL60M
G20309-2024	20GS-24FL60M
81508	24PCS-24FL60
81509	24PCS-32FL60
81510	32PCS-32FL60

## G20314 Series - Code 61 Flange 90 Degree Short

G20314-1208	12GS-8FL90S
G20314-1216	12GS-16FL90S
G20314-1616	16GS-16FL90S
G20314-1620	16GS-20FL90S
G20314-2020	20GS-20FL90S
G20314-2024	20GS-24FL90S
81535	24PCS-20FL90
81532	24PCS-24FL90
83413	24PCM-24FL90
81533	24PCS-32FL90
81534	32PCS-32FL90
81339	24PCS-24FL120
81340	32PCS-32FL125

**E39**

# Hydraulic Hose and Fittings

**DTC**

**Global Crimp Fittings - High Pressure**

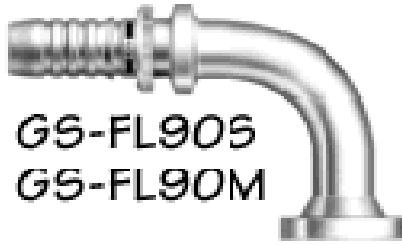

**GS-FL90S**  
**GS-FL90M**

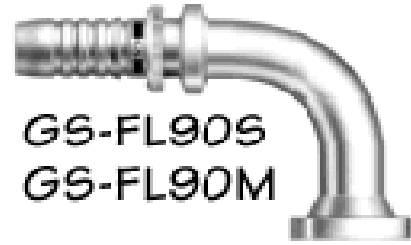

**GS-FL90S**  
**GS-FL90M**

**G20315 Series - Code 61 Flange 90 Degree Medium**

G20315-0608	6GS-8FL90M
G20315-0808	8GS-8FL90M
G20315-0812	8GS-12FL90M
G20315-1012	10GS-12FL90M
G20315-1212	12GS-12FL90M
G20315-1216	12GS-16FL90M
G20315-1616	16GS-16FL90M
G20315-1620	16GS-20FL90M
G20315-2016	20GS-16FL90M
G20315-2020	20GS-20FL90M
G20315-2024	20GS-24FL90-118
81284	24PCS-24FL90M
81328	24PCS-32FL90M
81337	32PCS-32FL90M

**G20317 Series - Code 61 Flange 30 Degree Long**

G20317-1616	16GS-16FL90-120
G20317-2020	20GS-20FL90-168
81327	24PCS-24FL90L
81329	24PCS-32FL90L
81338	32PCS-32FL90L



**GS-FLH**



**GS-FLH30M**

**G20350 Series - Code 62 Flange**

G20350-0808	8GS-8FLH
G20350-1008	10GS-8FLH
G20350-1012	10GS-12FLH
G20350-1212	12GS-12FLH
G20350-1216	12GS-16FLH
G20350-1612	16GS-12FLH
G20350-1616	16GS-16FLH
G20350-1620	16GS-20FLH
G20350-2016	20GS-16FLH
G20350-2020	20GS-20FLH
G20350-2024	20GS-24FLH
83346	24PCM-24FLH
83347	24PCM-32FLH
83047	32PCM-32FLH

**G20354 Series - Code 62 Flange 30 Degree**

G20354-1212	12GS-12FLH30M
G20354-1616	16GS-16FLH30M
G20354-2020	20GS-20FLH30M
G20354-2024	20GS-24FLH30M

**E40**

# Hydraulic Hose and Fittings

**DTC**

**Global Crimp Fittings - High Pressure**



**GS-FLH45M**



**GS-FLH90  
GS-FLH90S  
GS-FLH90M**

## G20357 Series - Code 62 Flange 45 Degree

G20357-0808	8GS-8FLH45M
G20357-1212	12GS-12FLH45M
G20357-1216	12GS-16FLH45M
G20357-1616	16GS-16FLH45M
G20357-1620	16GS-20FLH45M
G20357-2020	20GS-20FLH45M
G20357-2024	20GS-24FLH45M
81583	24PCS-24FLH45
81584	24PCS-32FLH45
81585	32PCS-32FLH45

## G20364 Series - Code 62 Flange 90 Degree

G20364-1216	12GS-16FLH90S
G20364-1616	16GS-16FLH90S
G20364-1620	16GS-20FLH90S
G20364-2020	20GS-20FLH90-076
G20364-2024	20GS-24FLH90S
81593	24PCS-24FLH90
81594	24PCS-32FLH90
81595	32PCS-32FLH90



**GS-FLH90  
GS-FLH90S  
GS-FLH90M**



**GS-FLH90  
GS-FLH90S  
GS-FLH90M**

## G20365 Series - Code 62 Flange 90 Degree Medium

G20365-0808	8GS-8FLH90M
G20365-0812	8GS-12FLH90M
G20365-1212	12GS-12FLH90M
G20365-1216	12GS-16FLH90M
G20365-1612	16GS-12FLH90M
G20365-1616	16GS-16FLH90M
G20365-1620	16GS-20FLH90M
G20365-2020	20GS-20FLH90M

## G20366 Series - Code 62 Flange 90 Degree Long

G20366-1212	12GS-12FLH90-100
G20366-1616	16GS-16FLH90-120
G20366-2020	20GS-20FLH90-120

**E41**

# Hydraulic Hose and Fittings

**DTC**

**Global Crimp Fittings - High Pressure**

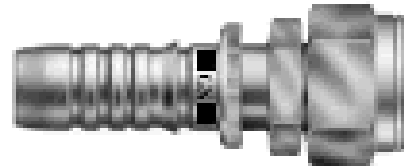
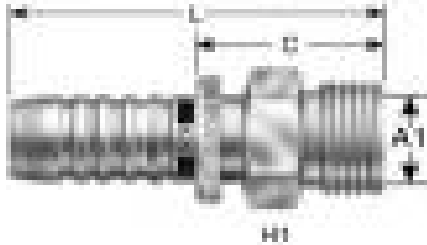

**GS-FDHORX**

## G20715 Series - Male DIN Heavy

G20715-0816	8GS-16MDH
G20715-1220	12GS-20MDH
G20715-1225	12GS-25MDH
G20715-1625	16GS-25MDH
G20715-1630	16GS-30MDH
G20715-2038	20GS-38FDLORX90M

## G20720 Series - Female DIN 24 Deg Cone with O-Ring Heavy Swivel

G20720-0612	6GS-12FDHORX
G20720-0614	6GS-14FDHORX
G20720-0814	8GS-14FDHORX
G20720-0816	8GS-16FDHORX
G20720-1020	10GS-20FDHORX
G20720-1025	10GS-25FDHORX
G20720-1220	12GS-20FDHORX
G20720-1225	12GS-25FDHORX
G20720-1630	16GS-30FDHORX
G20720-2038	20GS-38FDHORX
7343-0308	24PCM-38FDHX



**GS-FDHORX45M**



**GS-FDHORX90M**

## G20725 Series - Female DIN 24 Deg Cone with O-Ring Heavy Swivel 45 Degree

G20725-0816	8GS-16FDHORX45M
G20725-1020	10GS-20FDHORX45M
G20725-1220	12GS-20FDHORX45M
G20725-1225	12GS-25FDHORX45M
G20725-1625	16GS-25FDHORX45M
G20725-1630	16GS-30FDHORX45M
G20725-2038	20GS-38FDHORX45M

## G20730 Series - Female DIN 24 Deg Cone with O-Ring Heavy Swivel 90 Degree

G20730-0816	8GS-16FDHORX90M
G20730-1020	10GS-20FDHORX90M
G20730-1220	12GS-20FDHORX90M
G20730-1225	12GS-25FDHORX90M
G20730-1625	16GS-25FDHORX90M
G20730-1630	16GS-30FDHORX90M
G20730-2038	20GS-38FDHORX90M

**E42**

# Hydraulic Hose and Fittings

**DTC**

**Global Crimp Fittings - High Pressure**

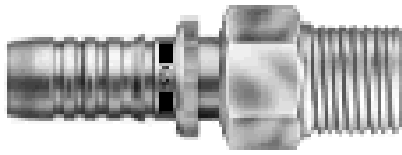

**GS-MBSPP**

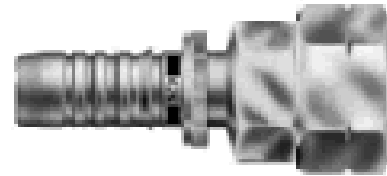

**GS-FBSPORX**

## G20810 Series - Male British Standard Pipe Parallel

G20810-0606	6GS-6MBSPP
G20810-0808	8GS-8MBSPP
G20810-1212	12GS-12MBSPP
G20810-1616	16GS-16MBSPP
G20810-2020	20GS-20MBSPP
81335	24PCS-24MBSPP
81336	32PCS-32MBSPP

## G20830 Series - Female British Standard Pipe Parallel Swivel

G20830-0606	6GS-6FBSPORX
G20830-0808	8GS-8FBSPORX
G20830-1212	12GS-12FBSPORX
G20830-1216	12GS-16FBSPORX
G20830-1616	16GS-16FBSPORX
G20830-2020	20GS-20FBSPORX
81117	24PCS-24FBSPPX
81118	32PCS-32FBSPPX

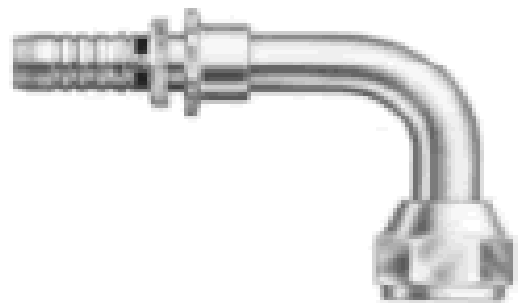
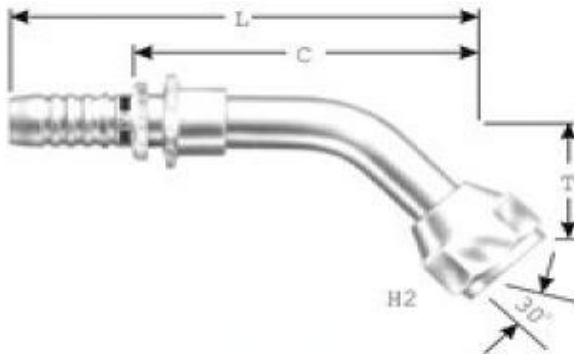

**GS-FBSPORX90M**

## G20831 Series - Female British Standard Pipe Parallel Swivel 45 Degree

G20831-0606	6GS-6FBSPORX45M
G20831-0808	8GS-8FBSPORX45M
G20831-1212	12GS-12FBSPORX45M
G20831-1616	16GS-16FBSPORX45M
G20831-2020	20GS-20FBSPORX45M

## G20832 Series - Female British Standard Pipe Parallel Swivel 90 Degree

G20832-0606	6GS-6FBSPORX90M
G20832-0808	8GS-8FBSPORX90M
G20832-1212	12GS-12FBSPORX90M
G20832-1616	16GS-16FBSPORX90M
G20832-2020	20GS-20FBSPORX90M

**E43**

# Hydraulic Hose and Fittings

**DTC**

**Global Crimp Fittings - High Pressure**

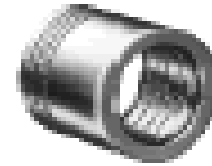
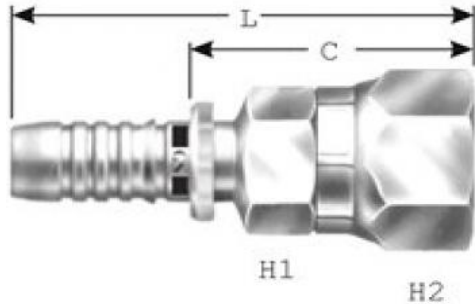

**GS-1F4**

## G20930 Series - Female JIS Swivel

G20930-1212	12GS-12FJISX
G20930-1616	16GS-16FJISX
G20930-2020	20GS-20FJISX
80967	24PCS-24FJISX
80968	32PCS-32FJISX

## GS Ferrule For 4 Spiral Hose

G20995-0406	6GS1F-4
G20995-0408	8GS1F-4
G20995-0410	10GS1F-4
G20995-0412	12GS1F-4
G20995-0416	16GS1F-4
G20995-0420	20GS1F-4

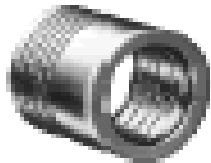

**GS-1F6**



## GS Ferrule For 6 Spiral Hose

G20995-0620	20GS1F-6
-------------	----------

## PCS - PCM Crimp Ferrule (Spiral)

81395	24PCS1F
81282	32PCS1F-G3K
83402	24PCM2F
83403	32PCM2F

**E44**